



# Grid-connected PV Inverter

SUN-18K-G05-AU

SUN-20K-G05-AU

SUN-25K-G05-AU

## User Manual



# Contents

1. Introduction	01
1.1 Appearance Introduction	01
1.2 Product Overview	02
1.3 Parts list	03
2. Safety warnings and instructions	04
2.1 Safety signs	04
2.2 Safety instructions	04
2.3 Notes for using	05
2.4 Maintenance of the System	05
3. Operation Interface	06
3.1 Interface View	06
3.2 Status Indicator	06
3.3 Buttons	07
3.4 LCD Display	07
4. Product installation	08
4.1 Select installation location	08
4.2 Inverter Installation	10
5. Electrical Connection	12
5.1 DC input terminal connection	12
5.2 AC input terminal connection	14
5.3 The connection of the ground line	16
5.4 Max. over current protection device	17
5.5 Inverter monitoring connection	17
5.6 Installation of datalogger	18
5.7 Configuration of Datalogger	18
6. Startup and Shutdown	18
6.1 Start up the inverter	19
6.2 Inverter Shutdown	19
6.3 DRM wiring diagram	20
7. Zero-export function via energy meter	21
7.1 Use of zero-export function	25
7.2 Notes while using zero export function	26
7.3 How to browse the load power of your PV grid-tieplant on monitoring platform	26
8. General Operation	28
8.1 The initial interface	28
8.2 Submenus in the Main Menu	30
8.3 System param setting	32
8.4 Running param set	32
8.5 Protect Param	42
8.6 Comm. param set	44
9. Repair and Maintenance	44
10. Error information and processing	44
10.1 Error code	45
11. Specification	49

# About This Manual

The manual mainly describes the product information, guidelines for installation, operation and maintenance. The manual cannot include complete information about the photovoltaic (PV) system.

## How to Use This Manual

Read the manual and other related documents before performing any operation on the inverter. Documents must be stored carefully and be available at all times. **Contents may be periodically updated or revised due to product development. The information in this manual is subject to change without notice.** The latest manual can be acquired via [service@deye.com.cn](mailto:service@deye.com.cn)

## Photovoltaic Grid-connected System

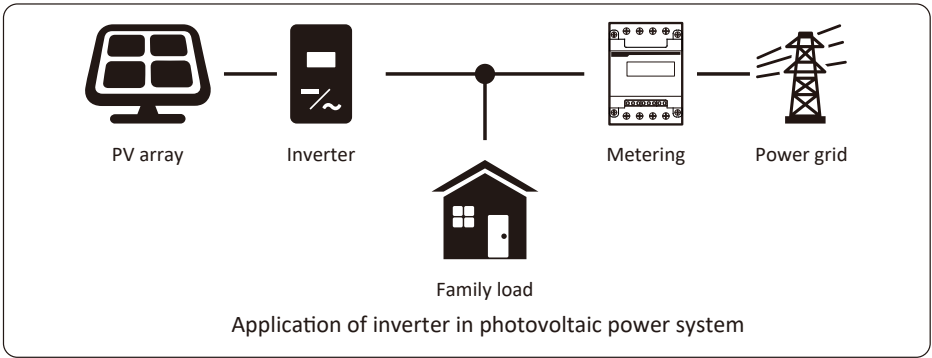

## 1. Introduction

### 1.1 Appearance Introduction

On-grid inverter can convert solar panel DC power into AC power which can directly input to the grid. Its appearance is shown below. These models contain SUN18K-G05-AU, SUN-20K-G05-AU, SUN-25K-G05-AU.

The following is collectively referred to as "inverter".

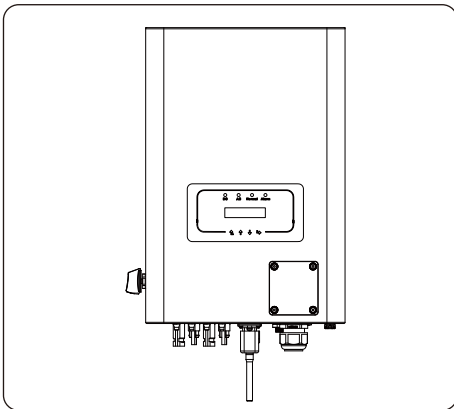

Pic 1.1 Front view

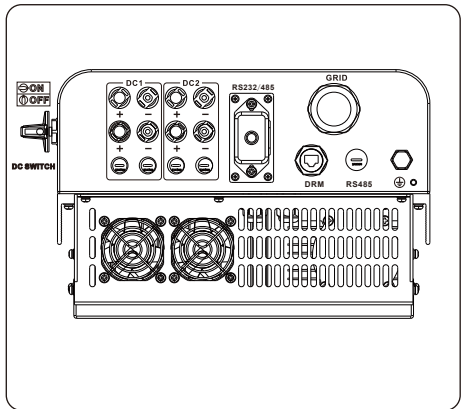

Pic 1.2 Bottom view

## 1.2 Product Overview

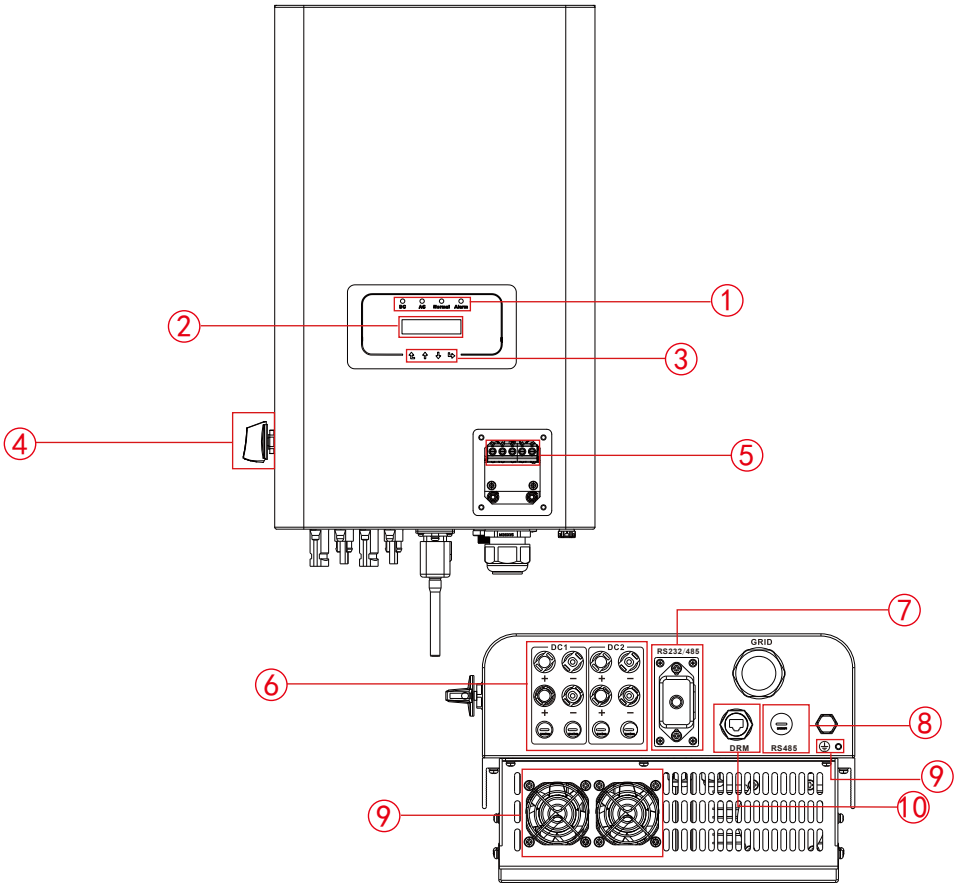

1: Inverter Indicators

4: DC switch

7: WiFi Interface

10: DRM Port

2: LCD display

5: Grid

8: RS485 Port

3: Function Buttons

6: PV input with two MPPT

9: Ground

### 1.3 Parts list

Please check the following table, to see whether all the parts are included in the package :

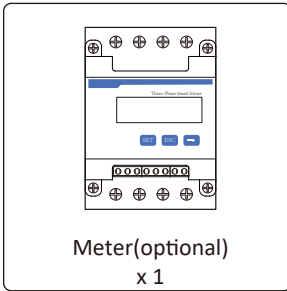
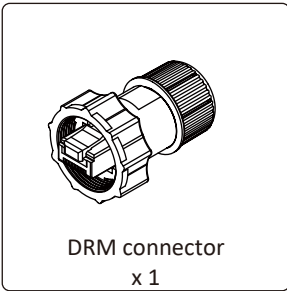
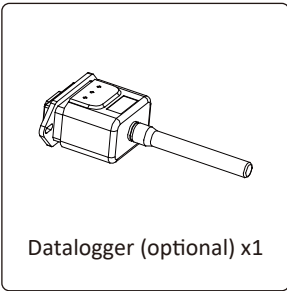
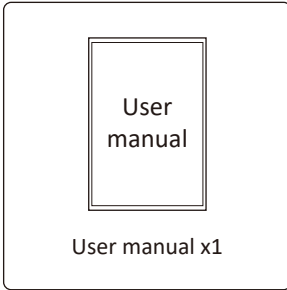
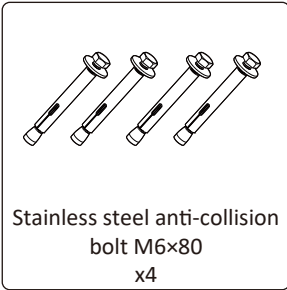
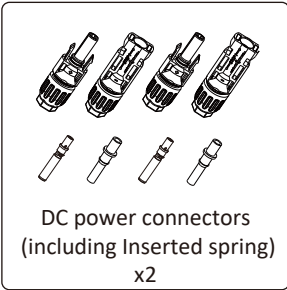
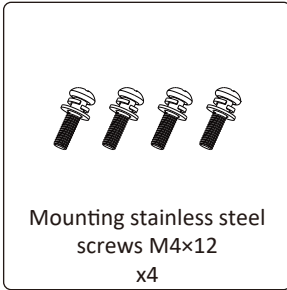
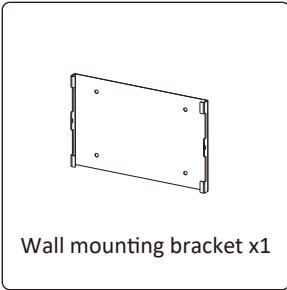
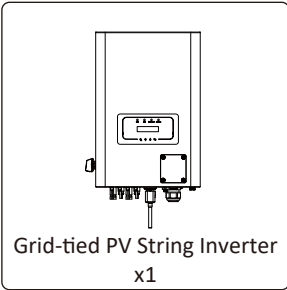

## 2. Safety warnings and instructions

Improper use may result in potential electric shock hazards or burns. This manual contains important instructions that should be followed during installation and maintenance. Please read these instructions carefully before use and keep them for future reference.

### 2.1 Safety signs

Safety symbols used in this manual, which highlight potential safety risks and important safety information, are listed as follows:



**Warning:**

Warning symbol indicates important safety instructions, which if not correctly followed, could result in serious injury or death.



**Shock Hazard:**

Caution, risk of electric shock symbol indicates important safety instructions, which if not correctly followed, could result in electric shock.



**Safety Hint:**

Note symbol indicates important safety instructions, which if not correctly followed, could result in some damage or the destruction of the inverter.



**High Temperature Hazard:**

Caution, hot surface symbol indicates safety instructions, which if not correctly followed, could result in burns.

### 2.2 Safety instructions



**Warning:**

Electrical installation of the inverter must conform to the safety operation rules of the country or local area.



**Warning:**

Inverter adopts non-isolated topology structure, hence must insure DC input and AC output are electrical isolated before operating the inverter. Strictly prohibit grounding the positive and negative poles of the PV string. Otherwise it will damage the inverter.



**Shock Hazard:**

Prohibit disassembling inverter case, there existing shock hazard, which may cause serious injury or death, please ask qualified person to repair.



**Shock Hazard:**

When PV module is exposed to sunlight, the output will generate DC voltage. Prohibit touching to avoid shock hazard.



**Shock Hazard:**

While disconnect the input and output of the inverter for maintenance, please wait for at least 5 mins until the inverter discharge the remnant electricity.



**High Temperature Hazard:**

Local temperature of inverter may exceed 80 °C while under operating. Please do not touch the inverter case.

### 2.3 Notes for using

The three phase string power inverter is designed and tested under related safety regulations. It can ensure the personal safety of the user. But as a electric device, it may cause shock or injury by incorrect operation. Please operate the unit under below requirements:

1. Inverter should be installed and maintained by qualified person under local standard regulations.
2. Must disconnect the AC side first, then disconnect DC side while doing installation and maintenance, after that, please wait at least 5 mins to avoid getting shocked.
3. Local temperature of the inverter may exceed 80 °C while under operating. Do not touch to avoid getting injured.
4. All electrical installation must be in accord with local electrical standards, and after obtaining the permission of the local power supply department, the professionals can connect the inverter to the grid.
5. Please take appropriate anti-static measure.
6. Please install where children can not touch.
7. When starting the inverters, first close the circuit breaker at the grid side, then close the DC side; when closing the inverters, first disconnect the circuit breaker at the AC side, then disconnect the DC side.
8. Don't insert or remove AC and DC terminals when the inverter is in normal operation.
9. The DC input voltage of the inverter must not exceed the maximum value of the model.

### 2.3 Maintenance of the System

The inverter is low maintenance, however, it is important that at least twice a year (for dusty environments this may need to be carried out weekly) all the cooling fans, air ducts are cleaned and dust free. Check if there are no fault codes.

### 3. Operation Interface

#### 3.1 Interface View

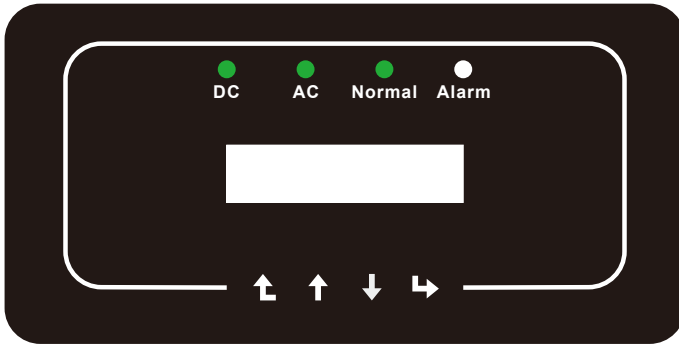

Pic 3.1 Front panel display

#### 3.2 Status Indicator

There are four LED status indicator lights in the front panel of the inverter. Please see table 3.1 for details.

<b>Indicator</b>	<b>status</b>	<b>Explanation</b>
● DC	on	Inverter detects DC input
	off	Low DC input voltage
● AC	on	Grid Connected
	off	Grid Unavailable
● NORMAL	on	Under normal operating
	off	Stop operating
● ALARM	on	Detected faults or report faults
	off	Under normal operating

Table 3.1 Status indicator lights



---

### 3.3 Buttons

There are four keys in the front panel of the Inverter(from left to right): Esc, Up, Down and Enter keys. The keypad is used for:

- Scrolling through the displayed options (the Up and Down keys);
- Access to modify the adjustable settings (the Esc and Enter keys).



### 3.4 LCD Display

The two-line Liquid Crystal Display (LCD) is located on the front panel of the Inverter, which shows the following information:

- Inverter operation status and data;
- Service messages for operator;
- Alarm messages and fault indications.

## 4. Product installation

### 4.1 Select installation location

To select a location for the inverter, the following criteria should be considered:

**WARNING: Risk of fire**

- Do not install the inverter in areas containing highly flammable materials or gases.
- Do not install the inverter in potentially explosive atmospheres.
- Do not install in small closed spaces where air can not circulate freely. To avoid overheating, always make sure the flow of air around the inverter is not blocked.
- Exposure to direct sunlight will increase the operational temperature of the inverter and may cause output power limiting. It is recommended that inverter installed to avoid direct sunlight or raining.
- To avoid overheating ambient air temperature must be considered when choosing the inverter installation location. It is recommended that using a sun shade minimizing direct sunlight when the ambient air temperature around the unit exceeds 100°F/40 C.

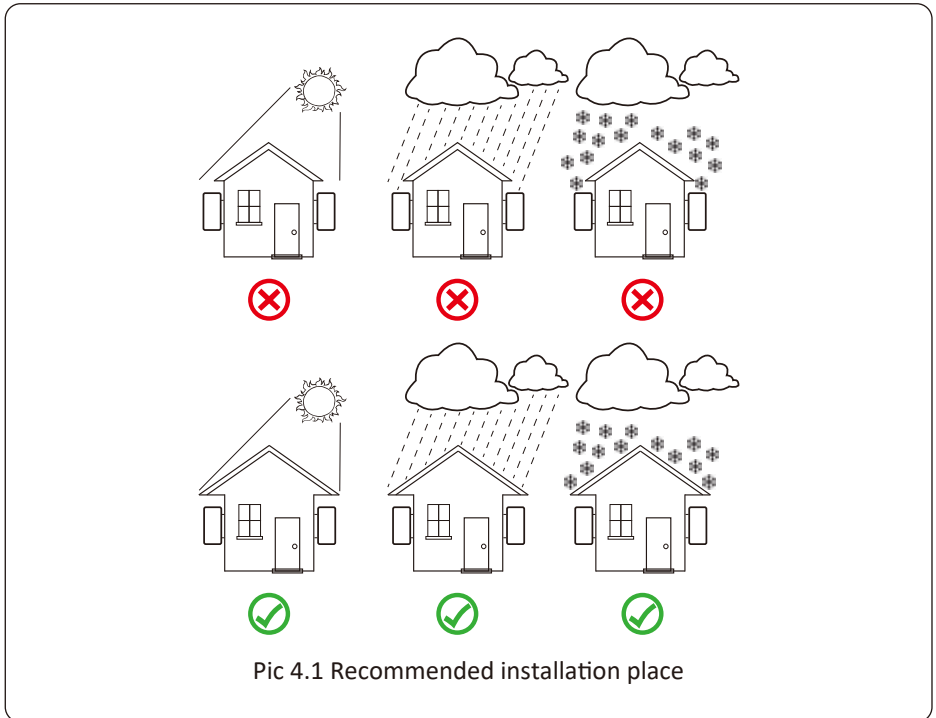

- Install on a wall or strong structure capable of bearing the weight.
- Install vertically with a maximum incline of  $\pm 15^\circ$ . If the mounted inverter is tilted to an angle greater than the maximum noted, heat dissipation can be inhibited, and may result in less than expected output power.
- If install more than one inverter, must leave at least 500mm gap between each inverter. And each inverter must be at least 500mm above and below. And must install the inverter at the place where children cannot touch. Please see picture 4.3.
- Consider whether the installation environment is helpful to see the inverter LCD display and indicator status clearly.
- Must offer a ventilate environment if inverter installed in the airtight house.



**Safety Hint:**

Do not place or store any items next to the inverter.

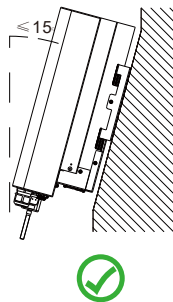
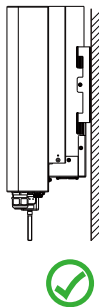
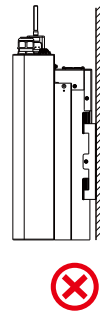
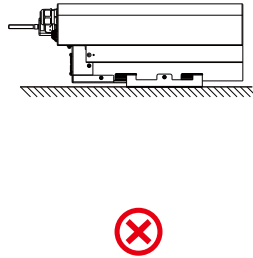
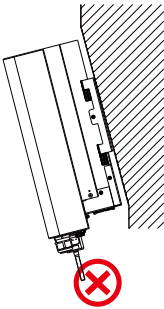

Pic 4.2 Installation Angle

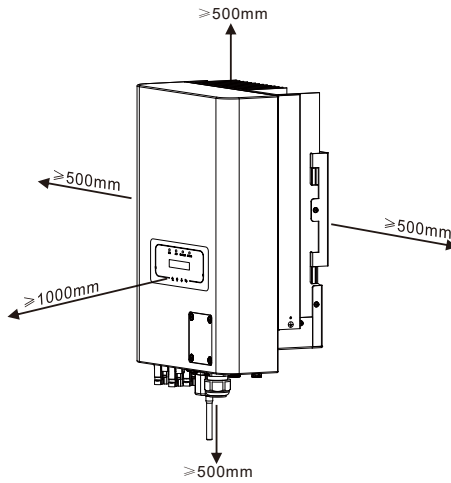

Pic 4.3 Installation Gap

## 4.2 Inverter Installation

The inverter is designed according to the wall mounted type installation, please use the wall mounted (the brick wall of the expansion bolt) when installing.

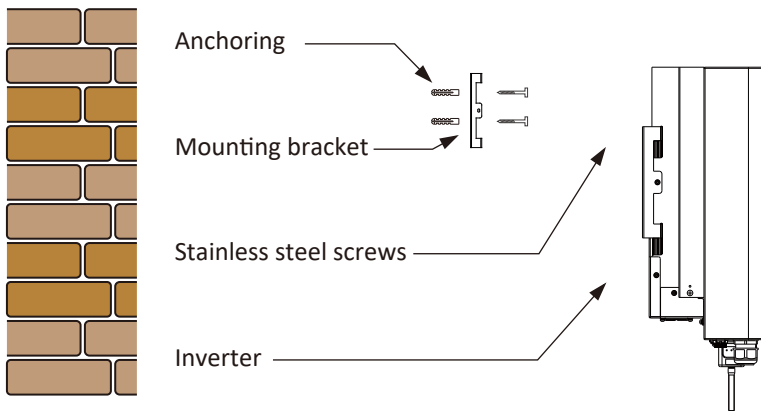

Pic 4.4 Inverter Installation

Procedure shows below:

1. Locate on the appropriate wall according to the bolt position on the mounting bracket, then mark the hole. On the brick wall, the installation must be suitable for the expansion bolt installation.

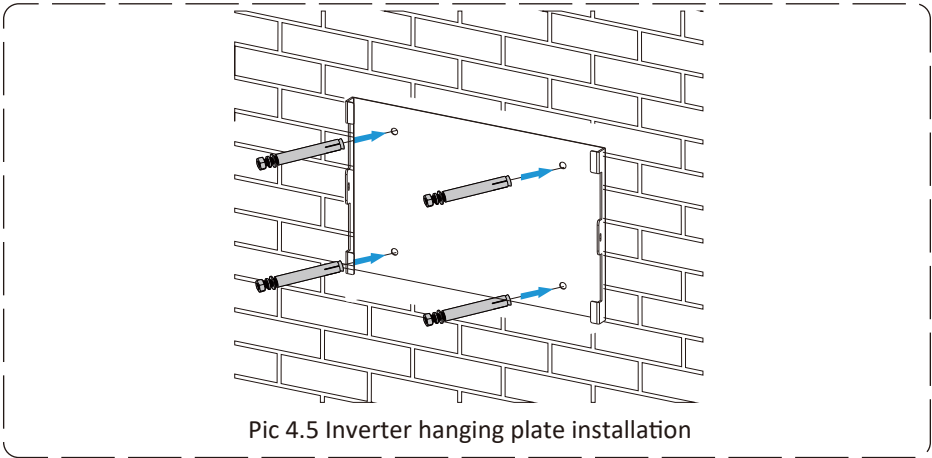

- 2. Ensure that the position of the installation holes on the wall is in accordance with the mounting plate, and the mounting rack is horizontally placed.
- 3. Hang the inverter to the top of the mounting rack and then use the M4 screw in the accessory to lock inverter heat sink to the hanging plate, to ensure that the inverter will not move.

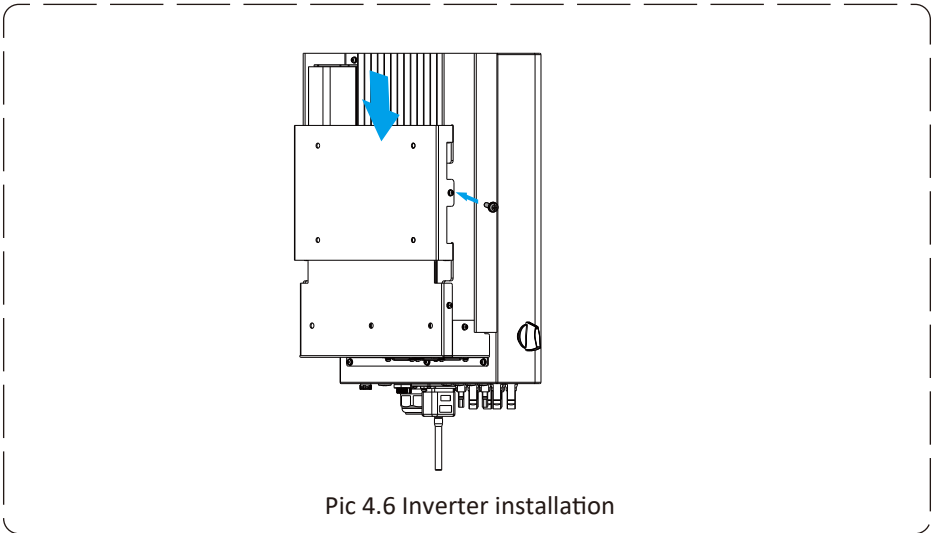

## 5 Electrical Connection

### 5.1 DC input terminal connection

1. Switch the Grid Supply Main Switch(AC)OFF.
2. Switch the DC Isolator OFF.
3. Assemble PV input connector to the inverter.



**Safety Hint:**

Please don't connect PV array positive or negative pole to the ground, it could cause serious damages to the inverter.



**Safety Hint:**

Before connection, please make sure the polarity of the output voltage of PV array matches the "DC+" and "DC-" symbols.



**Safety Hint:**

Before connecting inverter, please make sure the PV array open circuit voltage is within the 1000V of the inverter.



**GFDI fault:**

Before the inverter starts to connect to the grid, the inverter will first detect the impedance of PV + to ground, and the impedance of PV- to ground. If any of these impedance values is less than 33 kΩ, the inverter will not connect to the grid and will report an error F04 on its LCD. At the same time, the buzzer will sound. For the machine installed with Wi-Fi/GPRS, the alarm information can be seen on the corresponding monitoring website, and can also be received by the APP on the mobile phone.



Pic 5.1 DC+ male connector (MC4)



Pic 5.2 DC- female connector (MC4)



**Safety Hint:**

Please use approved DC cable for PV system.

Cable type	Cross section (mm <sup>2</sup> )	
	Range	Recommended value
Industry generic PV cable (model: PV1-F)	4.0~6.0 (12~10AWG)	4.0(12AWG)

Table 5.1 DC Cable Specifications

The steps to assemble the DC connectors are listed as follows:

a) Strip off the DC wire about 7mm, disassemble the connector cap nut (see picture 5.3).

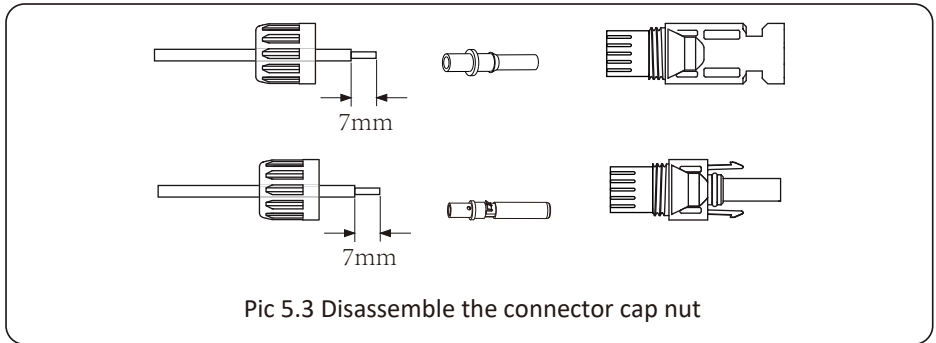

b) Crimping metal terminals with crimping pliers as shown in picture 5.4.

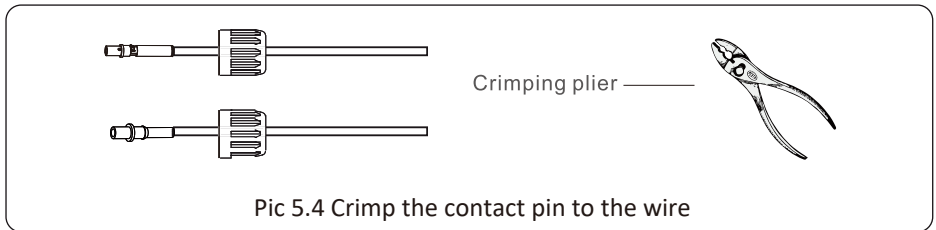

c) Insert the contact pin to the top part of the connector and screw up the cap nut to the top part of the connector. (as shown in picture 5.5).

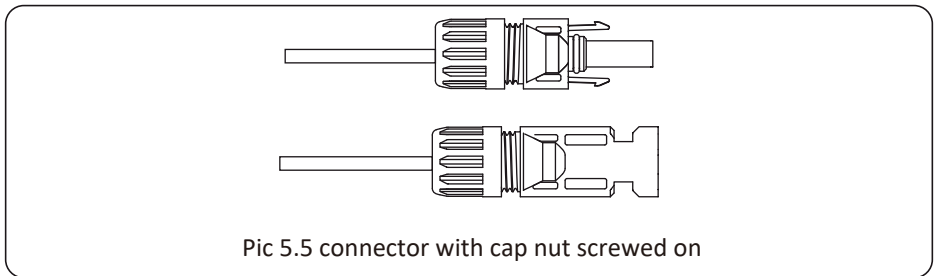

d) Finally insert the DC connector into the positive and negative input of the inverter, shown as picture 5.6

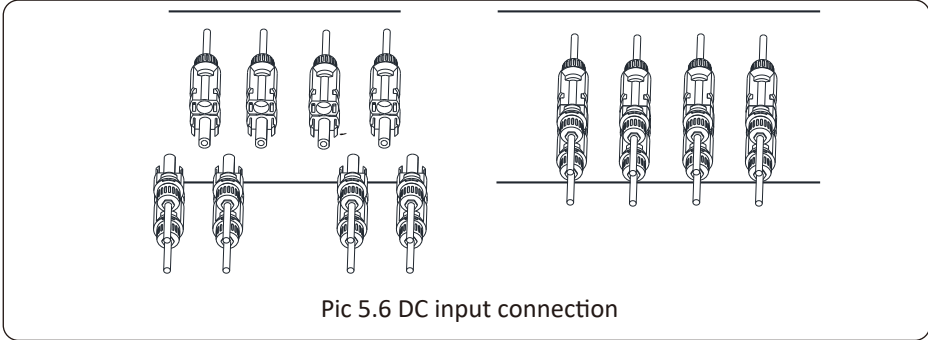

**Warning:** Sunlight shines on the panel will generate voltage, high voltage in series may cause danger to life. Therefore, before connecting the DC input line, the solar panel needs to be blocked by the opaque material and the DC switch should be 'OFF', otherwise, the high voltage of the inverter may lead to life-threatening conditions.



**Warning:** Use the DC power connector of the accessories. Do not interconnect the connectors of different manufacturers.

### 5.2 AC input terminal connection

Do not close the DC switch after the DC terminal is connected. Connect the AC terminal to the AC side of the inverter, the AC side is equipped with Three phase AC terminals that can be conveniently connected. Flexible cords are recommended for easy installation. The specifications are as shown in Table 5.2.



**Warning:** Prohibit using a single circuit breaker for multiple inverters, prohibit the connection of load between inverter circuit breakers.

Model	Cable CSA	Cable outer dia	AWG	Breaker	Max cable length
SUN-18/20/ 25KW-G05-AU	10mm <sup>2</sup>	20-30mm	8	45A/400V	Outside cable (3+N+PE)20m

Table 5.2 Cable information



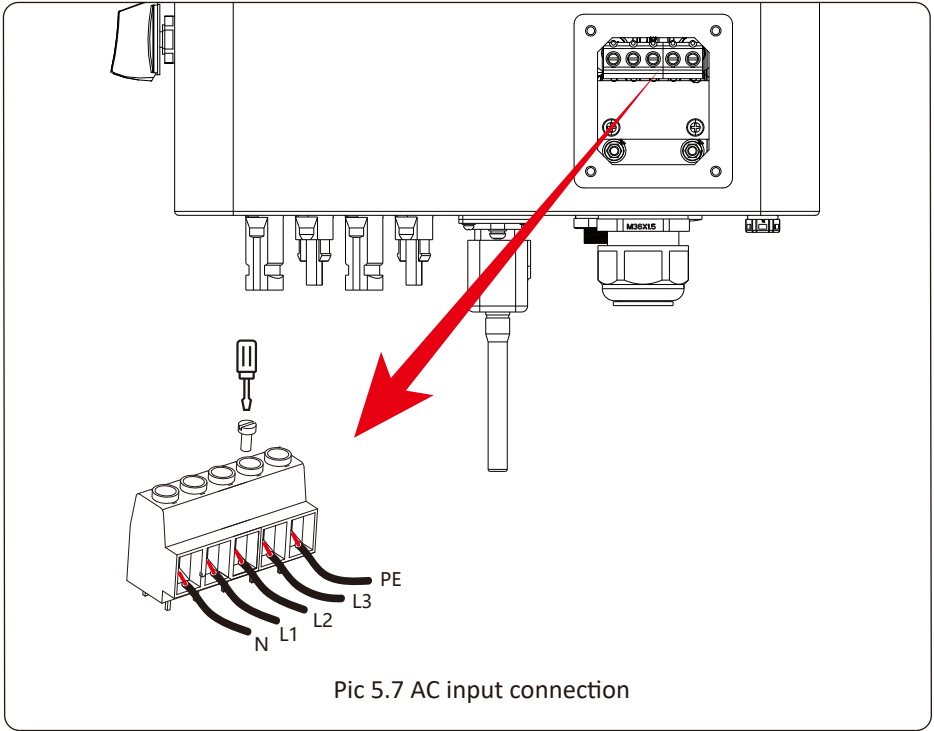

Pic 5.7 AC input connection



**Warning:**

Be sure that AC power source is disconnected before attempting to wire it to the unit.

1. Before making Grid port connection, be sure to turn off AC breaker or disconnector first.
2. Remove insulation sleeve 10mm length, unscrew the bolts, insert the wires according to polarities indicated on the terminal block and tighten the terminal screws. Make sure the connection is complete.
3. Then, insert AC output wires according to polarities indicated on the terminal block and tighten terminal. Be sure to connect corresponding N/L1/L2/L3 and PE wires to related terminals as well. (as shown in picture 5.7).
4. Make sure the wires are securely connected.

### 5.3 The connection of the ground line

Good grounding is good for resisting surge voltage shock and improving EMI performance. Therefore, before connecting AC, DC and communication cables, you need to ground the cable firstly. For a single system, just ground the PE cable. For multiple machine systems, all PE cables of the inverter need to be connected to the same grounding copper platoon to ensure the equipotential connection. The installation of the shell ground wire is shown as picture 5.11.

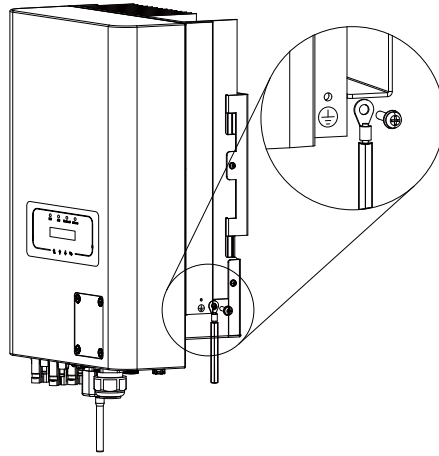

Pic 5.11 The installation of the shell ground wire



**Warning:**

Inverter has built-in leakage current detection circuit, If an external RCD is required, a type-A RCD with rated residual current of 300mA or higher is suggested. otherwise inverter may not work properly.

## 5.4 Max. over current protection device

In order to protect the inverter AC connection, it is recommended to install a circuit breaker to prevent overcurrent. See table 5.3 below.

<i>Inverter</i>	<i>Rated output voltage(V)</i>	<i>Rated output current(A)</i>	<i>Current for protection device(A)</i>
SUN-18K-G05-AU	230	29	45
SUN-20K-G05-AU	230	33.3	45
SUN-25K-G05-AU	230	36.2	45

Table 5.3 Recommended current protector specifications

## 5.5 Inverter monitoring connection

Inverter has the function of wireless remote monitoring. The inverter with Wi-Fi function is equipped with Wi-Fi Plug to connect the inverter and network. Wi-Fi Plug's operation, installation, Internet access, APP downloading and other processes are detailed in the instructions.

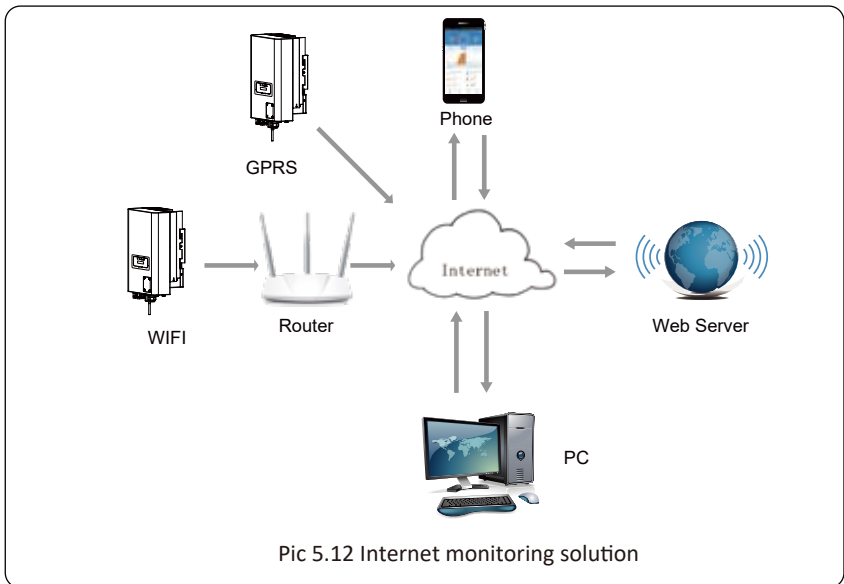

## 5.6 Installation of datalogger

When the inverter is out of the factory, the location of the installation of datalogger is sealed by a sealed plate as shown in Picture 5.14. When installing the datalogger, remove the sealing plate, replace it with the sealing plate with square hole in the accessories, and tighten the screws. Insert the datalogger into the interface and fix it with a screw. The configuration of the datalogger needs to be performed after various electrical connections have been completed and the inverter DC power on. When the inverter is on the DC power, it is determined whether the datalogger is normally electrified (The LED light shines out of the shell).

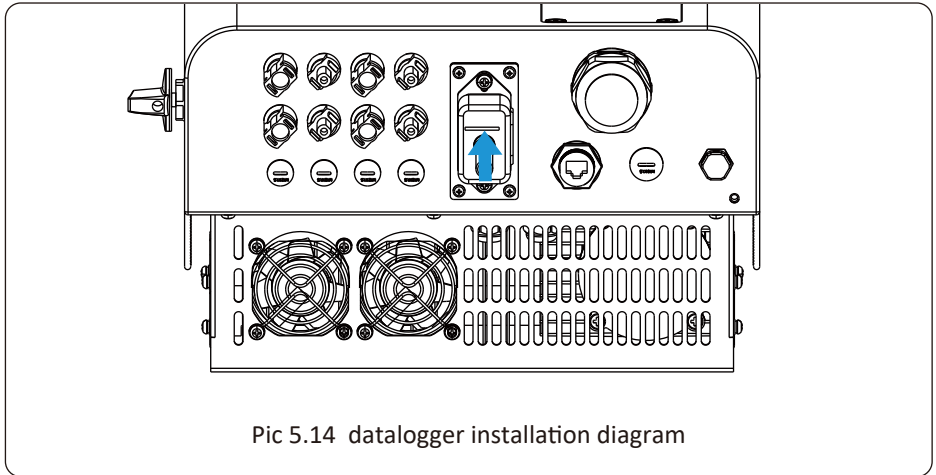

## 5.7 Configuration of datalogger

For the configuration of datalogger, please refer to illustrations of the datalogger.

## 6. Startup and Shutdown

Before starting the inverter, make sure that the inverter can meet the following conditions, otherwise it may result in fire or damage to the inverter. In this case, we do not undertake any responsibility. At the same time, to optimize the system configuration, it is recommended that the two inputs be connected to the same number of photovoltaic modules.

- a). The maximum open voltage of each set of photovoltaic modules shall not exceed 1000Vdc under any conditions.
- b). Each input of the inverter better use the same type of photovoltaic module in series.
- c). Total output power of pv shall not exceed the maximum input power of inverter, each photovoltaic modules shall not exceed the rated power of each channel.

---

## 6.1 Start up the inverter

When start up the three phase string inverter, should follow below steps:

1. First switch on the AC breaker.

2. Turn on the DC switch of the photovoltaic module, and if the panel provides sufficient starting voltage and power, the inverter will start.

3. NOTE: Choose the correct country code. (refer to section 8.5 of this manual)

Notice: Different distribution network operators in different countries have different requirements regarding grid connections of PV grid connected inverters. Therefore, it's very important to make sure that you have selected the correct country code according to requirements of local authority. Please consult qualified electrical engineer or personnel from electrical safety authorities about this.

4. When the ac voltage and DC voltage are normal, the inverter start-up is ready to begin. The inverter will first check the internal parameters and the grid parameters, while the liquid crystal will show that the inverter is self-checking.

5. If the parameter is within acceptable range, the inverter will generate energy. NORMAL indicator light is on.

## 6.2 Inverter Shutdown

Must follow below steps while shutting down the inverter:

1. Switch off the AC breaker.

2. Wait for 30 seconds, turn off the DC switch (if any), or simply disconnect the DC input connector. The inverter will close the LCD and all LED within two minutes.

### 6.3 DRM wiring diagram

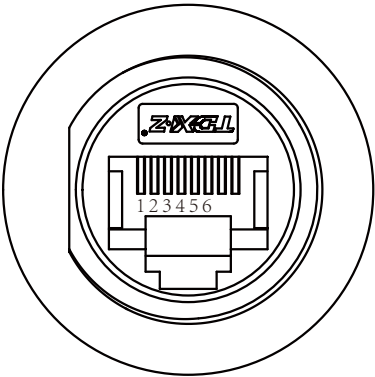
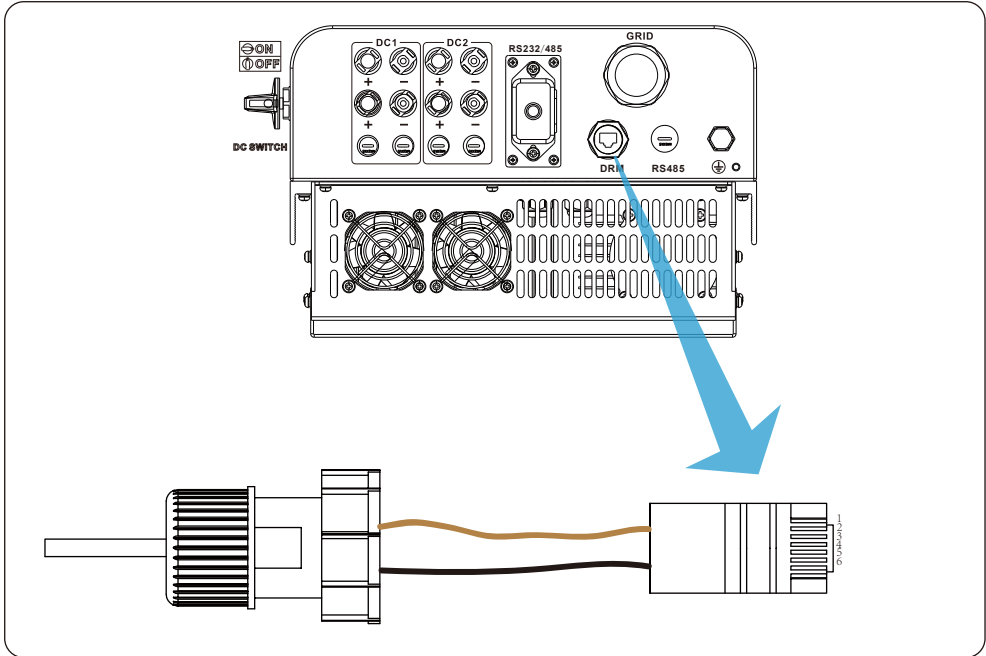

No.	
1	DRM1/5
2	DRM2/6
3	DRM3/7
4	DRM4/8
5	REF GEN/0
6	COM LOAD/0
7	
8	

---

## 7 Zero-export function via energy meter

When you are reading this, we believe that you have completed the connection according to the requirements of chapter 5, if you have been running your inverter at this time, and you want to use the zero-export function, please turn off AC and DC switch of the inverter, and wait for 5 minutes until the inverter completely discharged. Please follow below Picture 7.11 to connect the energy meter.

For system wiring diagram, the red line refers to L line (L1, L2, L3), the black line refers to the neutral line (N). Connecting energy meter RS485 cable to inverter's RS485 port. It's recommended to install an AC switch between the inverter and the utility grid, the specs of the AC switch are determined by the power of load.

If there is no integrated DC switch inside the inverter you purchased, we commend you to connect the DC switch. The voltage and current of the switch depend on the PV array you access.



Eastron SDM630-Modbus V2

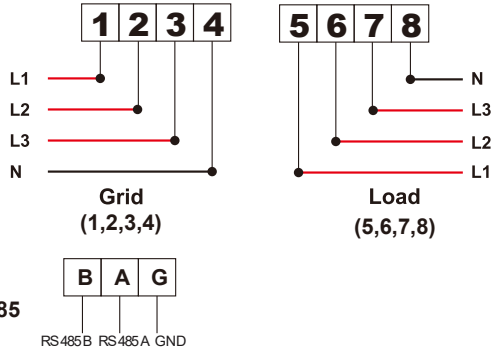

Pic 7.11 Eastron meter

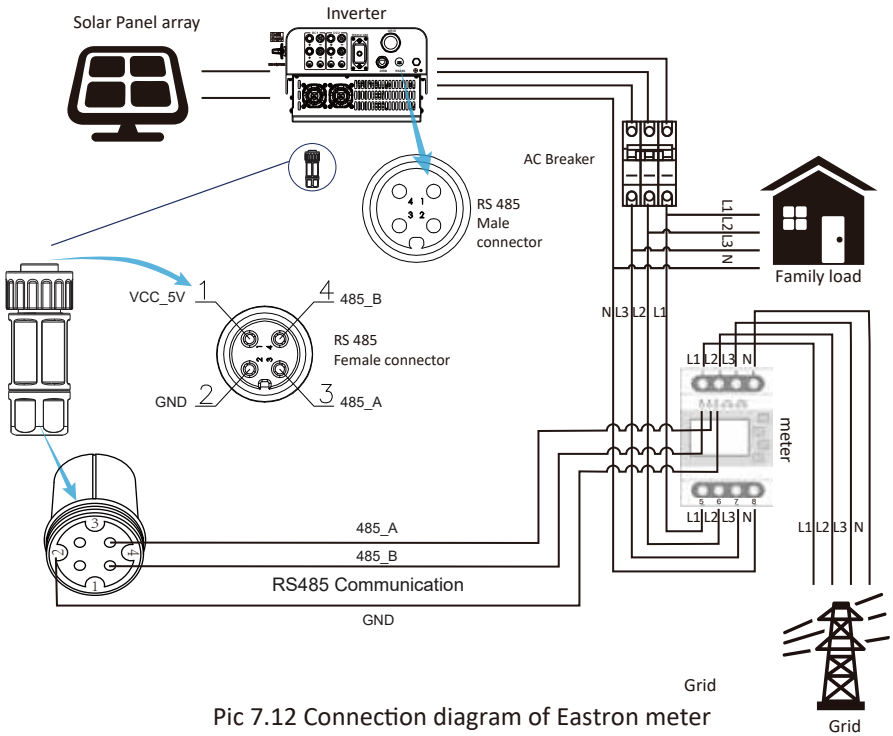

Pic 7.12 Connection diagram of Eastron meter



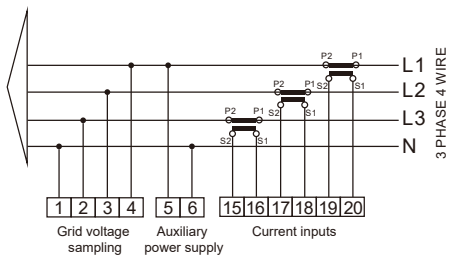
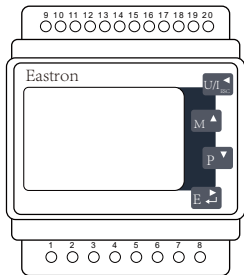

**RS 485**

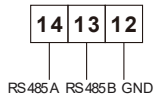

Eastron SDM630MCT Pic 7.13 Eastron meter

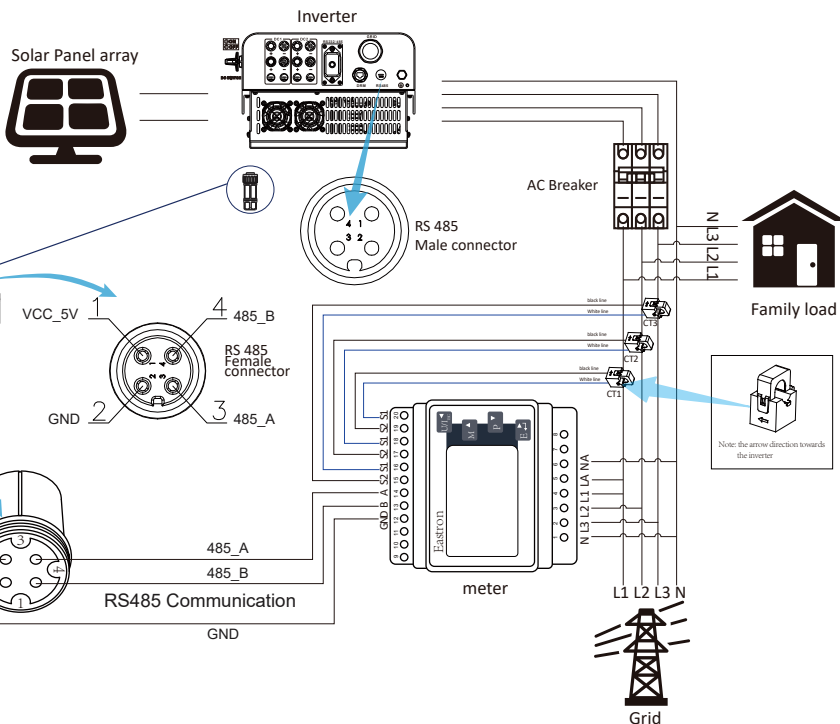

Pic 7.14 Connection diagram of Eastron meter

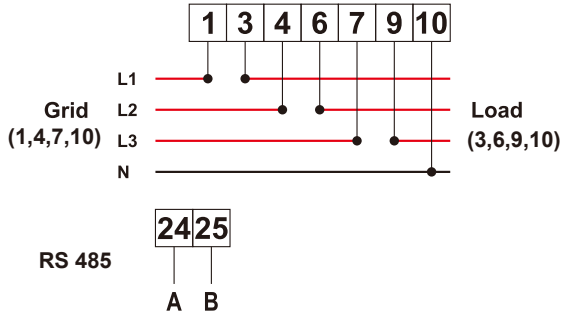
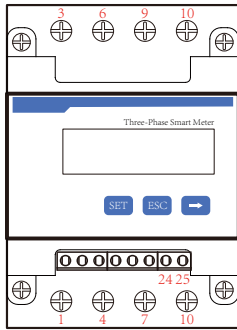

CHINT DTSU666

Pic 7.15 CHINT meter

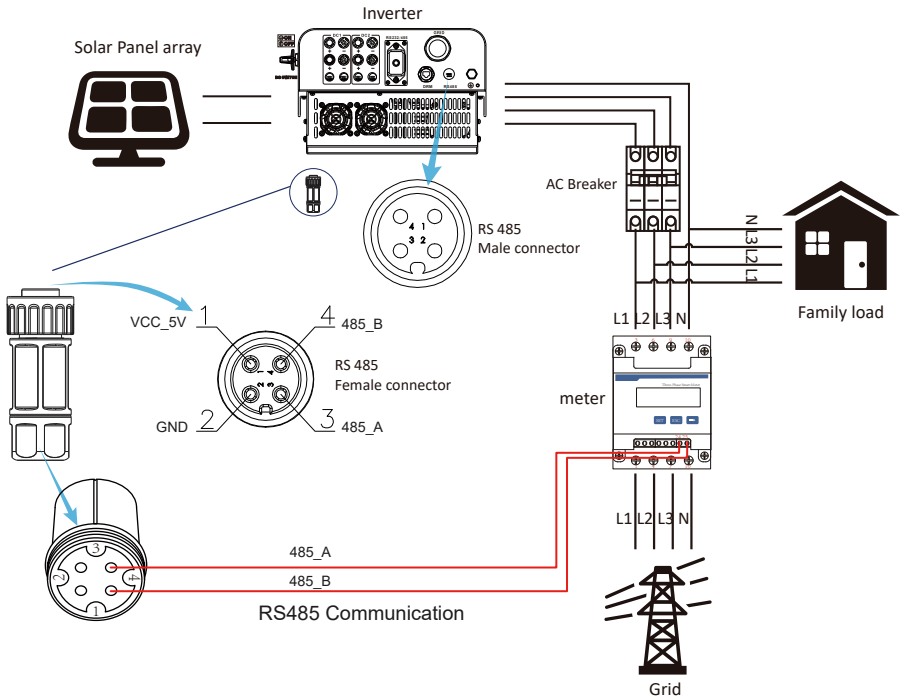

Pic 7.16 Connection diagram of CHINT meter

## 7.1 Use of zero-export function

When the connection is completed, the following steps should be referred to use this function:

1. Turn on the AC switch.
2. Turn on the DC switch, waiting for the inverter's LCD is turned on.
3. Press Enter button on the LCD panel in the main interface into the menu options, select [parameter setting] to enter setup submenu, and then select [running parameters] as shown in picture 7.17, at this time please input the default password 1234 through pressing the button [up down, enter], enter the operation parameter setting interface, shown as picture 7.18.



Pic 7.17 Parameter setting



Pic 7.18 Meter switch

4. Operate the button [up down], move setting cursor to energy meter and press the button [enter]. At this time you can turn on or turn off the energy meter by choosing [up down] button, please press [enter] button to confirm when setting done.
5. Move the cursor to [OK], press [enter] to save the settings and exit the running parameters page, otherwise the settings are invalid.
6. If set up successfully, you can return to the menu interface, and display the LCD to [home page] by press the [up down] button. If it displays [meter power XXW], the zero-export function setting is completed. Shown as picture 7.19.



Pic 7.19 Zero-export function via energy meter turn on

7. Meter power XXW shows positive means grid is supplying the load, and no power fed into grid. if meter power shows negative, it means PV energy is being sold to grid or energy meter wiring connection has problem.
8. After properly connection is done, wait for inverter starting. If the power of the PV array meets the current power consumption, the inverter will keep a certain output to counteract the power of the grid without backflow .

## 7.2 Notes while using zero export function

For your safety and the operation of limiter function of the inverter, we put forward the following suggestions and precautions:



### **Warning:**

Under zero export mode we strongly recommend that the two PV arrays are formed by the same number of PV panels of the same size, which will make the inverter more responsive to limit the power.



### **Safety Hint:**

While the utility power is negative and inverter has no output power, that means the orientation of the current sensor is wrong, please turn off the inverter and change orientation of the current sensor.

## 7.3 How to browse the load power of your PV grid-tie plant on monitoring platform?

If you want to browse load power of the system and how much energy (KWH) does it export to grid (inverter output power is used to power the load firstly and then the surplus energy will feed into grid). You also need to connect the meter according to above diagram. After the connection completed successfully, the inverter will show the load power on the LCD. **But please don't setup "Meter ON"**. Also, you will be able to browse the load power on the monitoring platform. The plant setting method as below description.

Firstly, go to the solarman platform (<https://pro.solarmanpv.com>, this link is for solarman distributor account; or <https://home.solarmanpv.com>, this link is for solarman end user account;) plant home page and click "edit"



And then choose your system type as “Self-consumption”

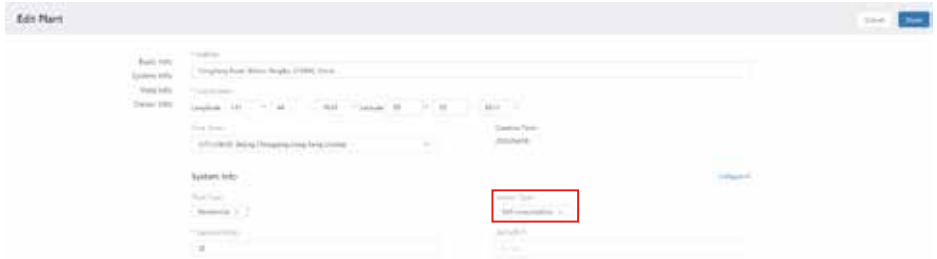

Secondly, go to plant page, if it shows the PV power, load power and grid power, which means the configuration is correct.



## 8. General Operation

During normal operation, the LCD shows the current status of the inverter, including the current power, total generation, a bar chart of power operation and inverter ID, etc. Press the Up key and the Down key to see the current DC voltage, DC current, AC voltage, AC current, inverter radiator temperature, software version number and Wifi connection state of the inverter.

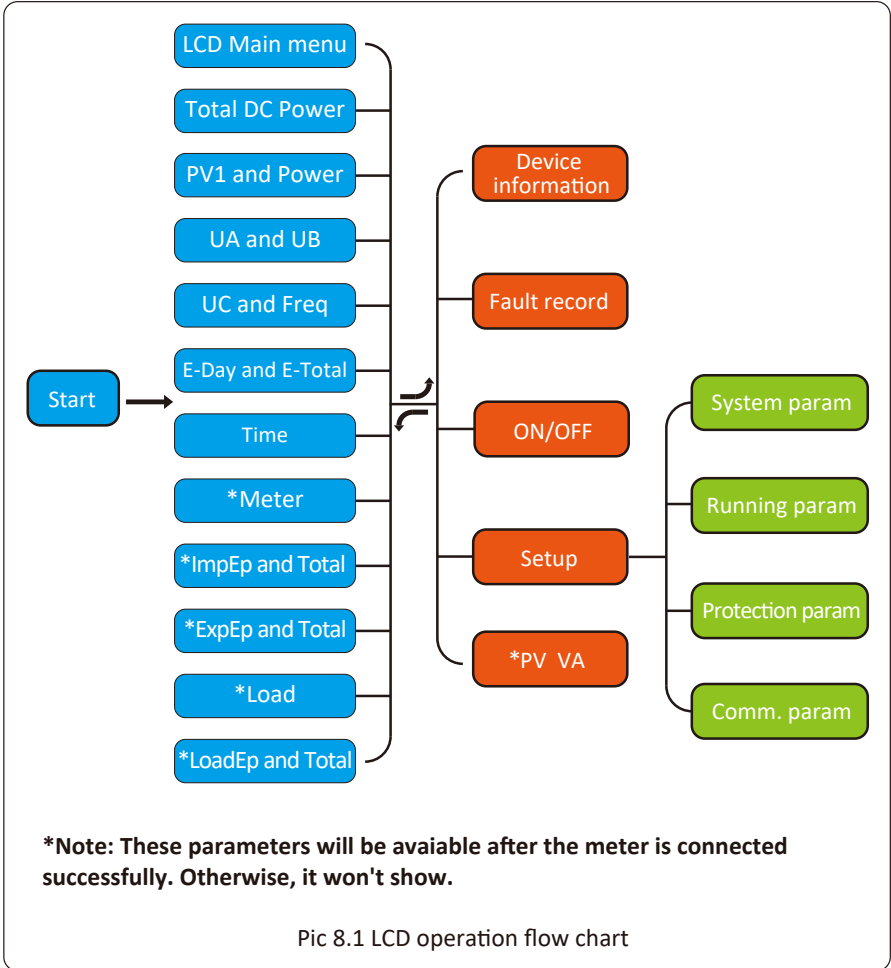

### 8.1 The initial interface

From the initial interface, you can check PV power, PV voltage, grid voltage, inverter ID, model and other information.

```
Power: 0W
State: Standby
```

```
Power: 0W
State: Com_Error
```

Pic 8.2 The initial interface

Press UP or Down, you can check inverter DC voltage, DC current, AC voltage, AC current and inverter temperature.

```
PV1: 0.0V 0.0A
```

```
Load
```

```
Power: 0W
```

Pic 8.3 PV input voltage and current information

Pic 8.4 Load power

```
UA: 234V 0.0A
```

```
UC: 0V 0.0A
```

```
UB: 0V 0.0A
```

```
Freq: 0.00Hz
```

Pic 8.5 Grid voltage and current information

Pic 8.6 Grid voltage and frequency

```
21 - 05 - 2020
```

```
Meter
```

```
15 : 57 : 08
```

```
Power: 0W
```

Pic 8.7 Time

Pic 8.8 Meter power

```
ImpEp: 0.00KWh
```

ImpEp: Daily energy purchased from grid;  
Total: Total energy purchased from grid.

```
Total : 0.00KWh
```

Pic 8.9 Electrical energy

```
ExpEp: 0.00KWh
```

ExpEp: Daily energy sold to grid;  
Total: Total energy sold to grid.

```
Total : 0.00KWh
```

Pic 8.10 Electrical energy

```
LoadEp: 0.00KWh
Total : 0.00KWh
```

LoadEp: Daily consumption;  
Total: Total energy consumption.

Pic 8.11 Load consumption

```
E-Day : 0Wh
E-Total : 134KWh
```

E-Day: Daily generation;  
E-Total: Total generation.

Pic 8.12 PV generation

### 8.2 Submenus in the Main Menu

There are five submenus in the Main Menu.

#### 8.2.1 Device information

You can see the LCD software Ver0201 and control board software Ver1970. In this interface, there are parameters such as rated power communication addresses.

```
Device Info. <<      GL1030  SN-01
Fault Record          ID:0000000012

ID:0000000012
Ver0201  Ver1970
```

Pic 8.13 Device information

#### 8.2.2 Fault Record

It can keep Eight fault records in the menu including time, customer can deal with it depends on the error code.

```
Device Info.          1 F35 200521 15
Fault Record <<      2 F56 200519 17
```

Pic 8.14 Fault Record



### 8.2.3 ON/OFF setting



Pic 8.15 ON/OFF setting

When the inverter is turned off, it stops working immediately, and go to standby mode and then will go to self-test program again. If it passed the self-test, it will start to work again.

### 8.2.4 PV VA setting



Pic 8.16 PV String current

Each PV string current and this function is optional.

### 8.2.5 Parameter setting

There are five submenus in the setup. Setting includes system param, run param, protect param, comm: param. All of these information for maintenance reference.



Pic 8.17 Submenus of the parameter setup

### 8.3 System param setting

System Param includes time set, language set, display set and factory reset.



Pic 8.18 System Param

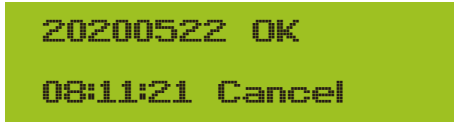

Pic 8.19 Time

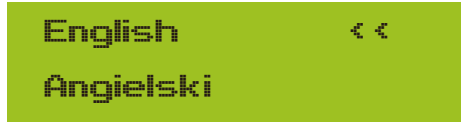

Pic 8.20 Language



Pic 8.21 LCD Screen settings



Pic 8.22 Delay time set



Pic 8.23 Reset to factory setting

### 8.4 Running param set



**Note:**

Password required-- only for access-authorized engineer. Un-authorized access may avoid the warranty. The initial password is 1234.



Pic 8.24 Password

### 8.4.1 ActiveP set



Adjust the output active power in %  
ReactMode::Multiple reactive power control modes

Pic 8.25

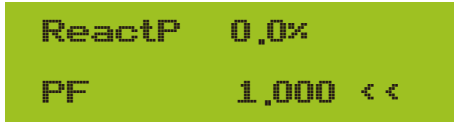

RecPt:In hysteresis mode, power is restored only when it is below this frequency

Pic 8.26

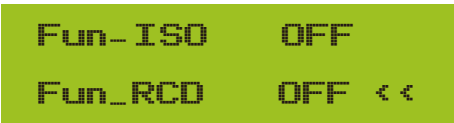

Fun\_ISO: Insulation resistance detection  
Fun\_RCD: Residual current detection

Pic 8.27



Self-check: Inverter's self-check time.The default value 60s

Island: Anti-islanding protection

Pic 8.28



Meter: Energy meter.If inverter will connect meter,then set here to ON

Pic 8.29



Feed\_In %: it is used to deploy how much power can be feed into grid.

For example, Feed\_in=50% of the 25KW model, which means Max. 12.5KW power can be feed into grid. And, this parameter is valid only after connecting a meter and the meter function is "ON".

Pic 8.30

WindTurbine

ARC OFF <<

Pic 8.31

OFDerate OFF

UGra 0,000% <<

Pic 8.32

Sunspec OFF

OK << Cancel

Pic 8.33

WindTurbine

ARC OFF <-

WindTurbine

ARC ON <-

WindTurbine

ARC CLR <-

Pic 8.34 Arc-Fault Detection

ARC OFF  
OFDerate OFF <-

ARC OFF  
OFDerate HYS <-

ARC ON  
OFDerate ON <-

Pic 8.35 active power droop

WindTurbine

ARC CLR < -

Clear arc fault manually

WindTurbine

ARC ON < -

Arc-fault detection function enable/disable

ARC ON

OFDMode OFF < -

Active power droop function enable/disable

ARC ON

OFDMode HYS < -

Hysteresis mode for active power droop

OFDerate HYS

UGRa 0,000% < <

the start frequency at which active power droop is taken to act

OFDerate ON

UGRa 0,000% < <

The slope of the active power reduction

# Over-frequency Response

This series inverter provides “over-frequency response” function. Long pressing the “OFD Mode” to enter the “over-frequency response” setting menu.



**Tab. 11-4** Definition of Over-frequency Response Parameters

Parameter	Range	Description
StrtPT	45HZ-65HZ	The Start frequency value for over-frequency response.
StopPT	45HZ-65HZ	The Stop frequency value for over-frequency response.
RecPT	45HZ-65HZ	In hysteresis mode, power is restored only when it is below this frequency
RecGra	[3,500] 0.01%Pmax/s	Rate of Power recovery(Percentage of active power)

For example, StrtPT: 50.5Hz, StopPT: 51.5Hz, RecPT: 50.1Hz, when the grid frequency increases beyond Start: 50.5Hz, the inverter will linearly reduce the power output with a gradient of 100% Pmax/Hz until it reaches StopPT: 51.5Hz .

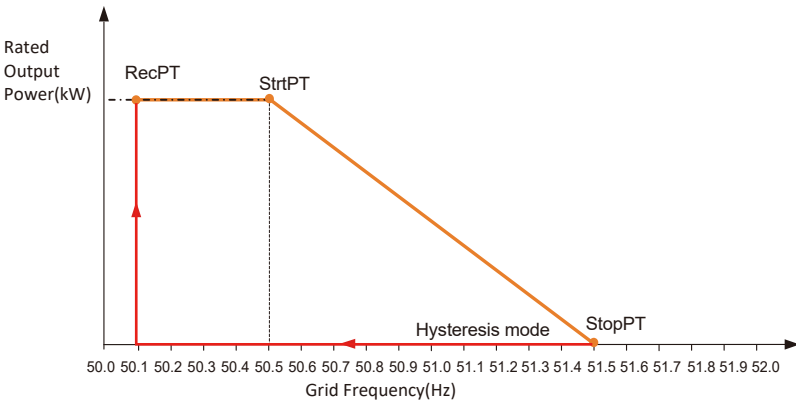

**Fig. 11-3** Frq-Watt Mode for Over-frequency Conditions

When the frequency exceeds StopPT: 51.5Hz, the inverter output should stop (ie 0 W).  
 When the frequency is lower than StopPT: 51.5 Hz, the inverter will linearly increase the power output with a gradient of 100% Pmax/Hz until it reaches StrtPT: 50.5 Hz.  
 In the hysteresis mode, when the frequency is lower than StopPT: 51.5 Hz, the inverter will not increase the power output until it is lower than RecPT: 50.1 Hz.

```

RecPt      50.10
RecGra     0.00 <<
  
```

```

RecGra     0.00
Back      <<
  
```

The inverter provides a reactive power regulation function.  
 Tap **Reactive Power Regulation Mode** to select proper regulation mode and set the corresponding parameters.

```

ActiveP    0%
ReactMode  OFF <<
  
```

```

ActiveP    0%
ReactMode  PER <<
  
```

```

ActiveP    0%
ReactMode  PF <<
  
```

```

ActiveP    0%
ReactMode  QU <<
  
```

Pic 8.36

- **"OFF" Mode**  
 The reactive power regulation function is disabled. The PF is fixed at +1.000
- **ReactiveP**  
 Adjust reactive power output in %.
- **"PF" Mode**  
 The power factor (PF) is fixed and the reactive power is regulated by the parameter PF. The PF ranges from 0.8 leading to 0.8 lagging.
  - Leading: the inverter is sourcing reactive power to the grid.
  - Lagging: the inverter is injecting reactive power into the grid.
- **"Q(U)" Mode**  
 The reactive power output of the inverter varies in response to the grid voltage.
- **"Q(P)" Mode**  
 The reactive power output by the inverter is controlled by the active power of the inverter.

StrPt 31,0% <<  
 StopPt 20,0%

Q1 80,0% <<  
 V1 -30,0%

Q2 90,0% <<  
 V2 -15,0%

Q3 100,0% <<  
 V3 0,0%

Q4 110,0% <<  
 V4 0,0%

Q5 120,0% <<  
 V5 15,0%

Q6 130,0% <<  
 V6 30,0%

RmpTime 2s  
 Back <<

Pic 8.37

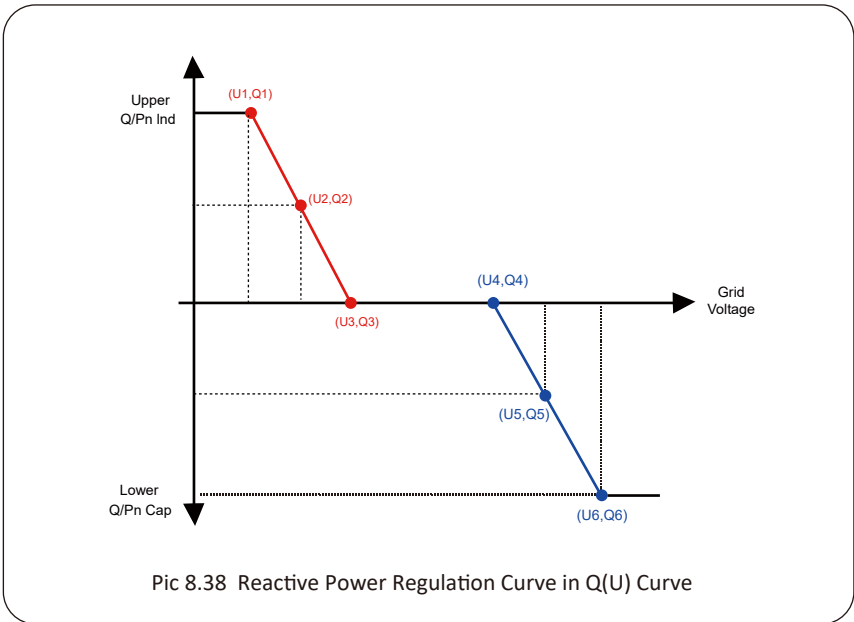



parameter	Range	description
QU_StrtPT	0%-130% Rate out power	The QU mode starts when the active power is greater than this value
QU_StopPT	0%-130% Rate out power	The QU mode stops when the active power is less than this value
Q1	-60% -60% Q/Pn	Value of Q/Pn at point (U1,Q1) on the Q(U) mode curve
V1	0-110% VRated	Grid voltage limit at point (U1,Q1) on the Q(U) mode curve
Q2	-60% -60% Q/Pn	Value of Q/Pn at point (U2,Q2) on the Q(U) mode curve
V2	0-110% VRated	Grid voltage limit at point (U2,Q2) on the Q(U) mode curve
Q3	-60% -60% Q/Pn	Value of Q/Pn at point (U3,Q3) on the Q(U) mode curve
V3	0-110% VRated	Grid voltage limit at point (U3,Q3) on the Q(U) mode curve
Q4	-60% -60% Q/Pn	Value of Q/Pn at point (U4,Q4) on the Q(U) mode curve
V4	0-110% VRated	Grid voltage limit at point (U4,Q4) on the Q(U) mode curve
Q5	-60% -60% Q/Pn	Value of Q/Pn at point (U5,Q5) on the Q(U) mode curve
V5	0-110% VRated	Grid voltage limit at point (U5,Q5) on the Q(U) mode curve
Q6	-60% -60% Q/Pn	Value of Q/Pn at point (U6,Q6) on the Q(U) mode curve
V6	0-110% VRated	Grid voltage limit at point (U6,Q6) on the Q(U) mode curve
RMpTime	0-1000s	Increase or decrease the time required for the reactive power to reach the specified value of the curve.

### "Q(U)" Mode Parameters Explanation

## “Q(P)” Mode

The reactive power output by the inverter is controlled by the active power of the inverter.

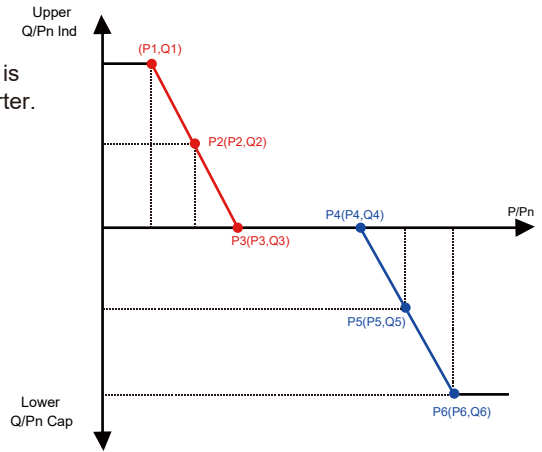

Pic 8.39 Reactive Power Regulation Curve in Q(P) Mode

ActiveP	20,0%
QMode	QP < -

P1	0,0%	<<
Q1	0,0%	

P2	0,0%	<<
Q2	0,0%	

P3	0,0%	<<
Q3	0,0%	

P4	0,0%	<<
Q4	0,0%	

P5	0,0%	<<
Q5	0,0%	

P6	0,0%	<<
Q6	0,0%	

OK	<<	Cancel
----	----	--------

parameter	Range	description
P1	0%-100% Pn	Value of Q/Pn at point (P1,Q1) on the Q(P) mode curve
Q1	-60% -60% Q/Pn	Grid voltage limit at point (P1,Q1) on the Q(P) mode curve
P2	0%-100% Pn	Value of Q/Pn at point (P2,Q2) on the Q(P) mode curve
Q2	-60% -60% Q/Pn	Grid voltage limit at point (P2,Q2) on the Q(P) mode curve
P3	0%-100% Pn	Value of Q/Pn at point (P3,Q3) on the Q(P) mode curve
Q3	-60% -60% Q/Pn	Grid voltage limit at point (P3,Q3) on the Q(P) mode curve
P4	0%-100% Pn	Value of Q/Pn at point (P4,Q4) on the Q(P) mode curve
Q4	-60% -60% Q/Pn	Grid voltage limit at point (P4,Q4) on the Q(P) mode curve
P5	0%-100% Pn	Value of Q/Pn at point (P5,Q5) on the Q(P) mode curve
Q5	-60% -60% Q/Pn	Grid voltage limit at point (P5,Q5) on the Q(P) mode curve
P6	0%-100% Pn	Value of Q/Pn at point (P6,Q6) on the Q(P) mode curve
Q6	-60% -60% Q/Pn	Grid voltage limit at point (P6,Q6) on the Q(P) mode curve

### "Q(P)" Mode Parameters Explanation

## 8.5 Protect Param



**Note:**

Engineer Only.

We will set the param depends on the safety requirements, so customers don't need to reset it. The password is same as 8.4 Running param

**Note:**

For compliance with AS/NZS 4777.2:2020 please select from Regions Australia A/B/C and New Zealand. Please contact your local grid operator on which region to select



Pic 8.31 Password

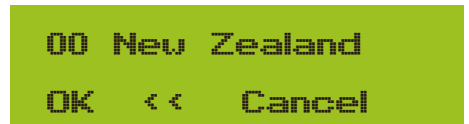
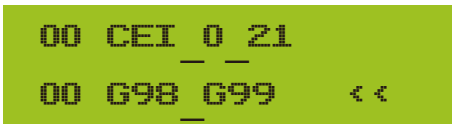
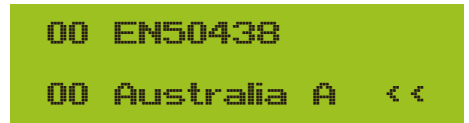
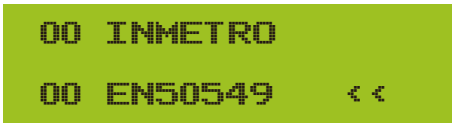

**Note:**

Engineer only.

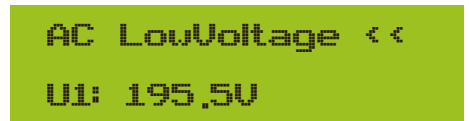
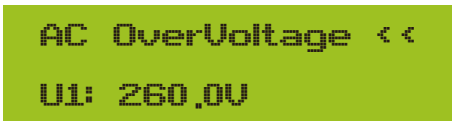

AC OverVoltage <<

U2: 265,0V

Tripping Time2 <<

Time2: 500ms

AC OverVoltage <<

U3: 270,0V

Tripping Time3 <<

Time3: 200ms

AC OverFreq <<

1 : 52,00Hz

Tripping Time1 <<

Time1: 2000ms

AC OverFreq <<

2 : 53,00Hz

Tripping Time2 <<

Time2: 500ms

AC OverFreq <<

3 : 54,00Hz

AC LowVoltage <<

U2: 185,0V

Tripping Time2 <<

Time2: 500ms

AC LowVoltage <<

U3: 160,0V

Tripping Time3 <<

Time3: 200ms

AC LowFreq <<

1 : 48,00Hz

Tripping Time1 <<

Time1: 2000ms

AC LowFreq <<

2 : 47,00Hz

Tripping Time2 <<

Time2: 500ms

AC LowFreq <<

3 : 46,00Hz



Pic 8.32 "CUSTOMIZED"

Please set the proper grid parameters according to the requirements of your current country's grid regulations. If you are not clear about it, please consult your installer.

### 8.6 Comm. param set

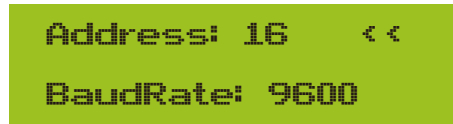

Pic 8.33 Comm. Param

## 9. Repair and Maintenance

String type inverter doesn't need regular maintenance. However, debris or dust will affect heat sink's thermal performance. It is better to clean it with a soft brush. If the surface is too dirty and affect the reading of LCD and LED lamp, you can use wet cloth to clean it up.



**Warning:**

When the device is running, the local temperature is too high and the touch can cause burns. Turn off the inverter and wait for it cooling, then you can clean and maintain.



**Warning:**

No solvent, abrasive materials or corrosive materials can be used for cleaning any parts of the inverter.

## 10. Error information and processing

Inverter has been designed in accordance with international grid tied standards for safety, and electromagnetic compatibility requirements. Before delivering to the customer the inverter has been subjected to several tests to ensure its optimal operation and reliability.

## 10.1 Error code

If there is any failure, the LCD screen will display an alarm message. In this case, the inverter may stop feeding energy into the grid. The alarm description and their corresponding alarm messages are listed in Table 10.1.

<b>Error code</b>	<b>Description</b>	<b>Ongrid - Three Phase</b>
F01	DC input polarity reverse fault	Check the PV input polarity.
F02	DC insulation impedance permanent fault	Check the grounding cable of inverter.
F03	DC leakage current fault	Hardly appear the code. Never ever happened so far.
F04	Ground fault GFDI	Check the solar panel output connection.
F05	Read the memory error	Failure in reading memory (EEPROM). Restart the inverter if the fault still exists, contact your installer or Deye service.
F06	Write the memory error	Failure in writing memory (EEPROM). Restart the inverter if the fault still exists, contact your installer or Deye service.
F07	GFDI blown fuse	Hardly appear the code. Never ever happened so far.
F08	GFDI grounding touch failure	Hardly appear the code. Never ever happened so far.
F09	IGBT damaged by excessive drop voltage	Hardly appear the code. Never ever happened so far.
F10	Auxiliary switch power supply failure	1. It tells the DC 12V is not existed. 2. Restart the inverter, if the fault still exists, please contact your installer.
F11	AC main contactor errors	Hardly appear the code. Never ever happened so far.
F12	AC auxiliary contactor errors	Hardly appear the code. Never ever happened so far.
F13	Working mode changed/Grid mode changed	1. Lost of one phase or AC voltage detection circuit or relays not closed (old inverter not have relays detection function). 2. Restart the inverter, if the error still exists, please contact your installer or Deye service.
F14	DC firmware over current	Hardly appear the code. Never ever happened so far.
F15	AC firmware over current	1. The internal AC sensor or detection circuit on control board or connection wire may loose. 2. Restart the inverter, if the error still exists, please contact your installer or Deye service.
F16	GFCI(RCD) Ac leakage current fault	1. This fault means the average leakage current is over 300mA. Check whether DC power supply or solar panels is ok, then check 'Test data' -> 'dil' value is about 40; Then check the leakage current sensor or circuit (the following picture). Checking test data needs using big LCD. 2. Restart the inverter, if the error still exists, please contact your installer or Deye service.
F17	Three phase current, over-current fault	Hardly appear the code. Never ever happened so far.
F18	AC over current fault of hardware	1. Check AC sensor or detection circuit on control board or connection wire. 2. Restart the inverter or factory reset, if the error still exists, please contact your installer or Deye service.
F19	All hardware failure synthesis	Hardly appear the code. Never ever happened so far.

<b>Error code</b>	<b>Description</b>	<b>Ongrid - Three Phase</b>
F20	DC over current fault of the hardware	<ol style="list-style-type: none"> <li>1. Check whether solar panel output current is within the allowed range.</li> <li>2. Check DC current sensor and its detection circuit.</li> <li>3. Check if the inverter FW version is suitable for the hardware.</li> <li>4. Restart the inverter, if the error still exists, please contact your installer or Deye service.</li> </ol>
F21	DC leakage flow fault	Hardly appear the code. Never ever happened so far.
F22	Crash stop (if there is a stop button)	Contact your installer for help.
F23	AC leakage current is transient over current	<ol style="list-style-type: none"> <li>1. This fault means the leakage current is above 30mA suddenly. Check whether DC power supply or solar panels is ok, then check 'Test data'-&gt; 'dil' value is about 40; Then check the leakage current sensor or circuit. Check test data needs using big LCD.</li> <li>2. Restart the inverter, if the fault still exists, contact your installer or Deye service.</li> </ol>
F24	DC insulation impedance failure	<ol style="list-style-type: none"> <li>1. Check Vpe resistance on main board or detection on control board. Check PV panels is OK. Many times this issue is the PV problem.</li> <li>2. Check whether the PV panel (aluminum frame) is grounded well and inverter is grounded well. Open the cover of inverter and then check the inside ground cable is fixed well on the shell.</li> <li>3. Check if the AC/DC cable, terminal block are shorted to ground or the insulation is damaged.</li> <li>4. Restart the inverter, if the fault still exists, contact your installer or Deye service.</li> </ol>
F25	DC feedback fault	Hardly appear the code. Never ever happened so far.
F26	The DC busbar is unbalanced	<ol style="list-style-type: none"> <li>1. Check whether the 'BUSN' cable or driver board power supply cable is loose.</li> <li>2. Restart the inverter, if the fault still exists, contact your installer or Deye service.</li> </ol>
F27	DC end insulation error	Hardly appear the code. Never ever happened so far.
F28	Inverter 1 DC high fault	Hardly appear the code. Never ever happened so far.
F29	AC load switch failure	Hardly appear the code. Never ever happened so far.
F30	AC main contactor failure	<ol style="list-style-type: none"> <li>1. Check relays and AC voltage of relays.</li> <li>2. Check relays driver circuit. Check if the software is not suitable for this inverter. (Old inverter not have relays detection function)</li> <li>3. Restart the inverter, if the fault still exists, contact your installer or Deye service.</li> </ol>
F31	Dc boost soft start	<ol style="list-style-type: none"> <li>1. At least one Relay can't be closed. Check relays and its driver signal. (Old inverter not have relays detection function)</li> <li>2. Restart the inverter, if the fault still exists, contact your installer or Deye service.</li> </ol>
F32	Inverter 2 dc high fault	Hardly appear the code. Never ever happened so far.
F33	AC over current	Hardly appear the code. Never ever happened so far.
F34	AC current over load	Hardly appear the code. Never ever happened so far.
F35	No AC grid	<ol style="list-style-type: none"> <li>1. Check AC grid voltage. Check AC voltage detection circuit. Check if the AC connector in good condition. Check whether the AC grid is normal in voltage.</li> <li>2. Restart the inverter, if the fault still exists, contact your installer or Deye service.</li> </ol>



<b>Error code</b>	<b>Description</b>	<b>Ongrid - Three Phase</b>
F36	AC grid phase error	Hardly appear the code. Never ever happened so far.
F37	AC three-phase voltage unbalance failure	Hardly appear the code. Never ever happened so far.
F38	AC three-phase current unbalance failure	Hardly appear the code. Never ever happened so far.
F39	AC over current(one cycle)	1. Check AC current sensor and its circuit. 2. Restart the inverter, if the fault still exists, contact your installer or Deye service.
F40	DC over current	Hardly appear the code. Never ever happened so far.
F41	AC Line W,U over voltage	Check the AC voltage protection setting. And Check if the AC cable is too thin.Check the voltage difference between LCD and meter.
F42	AC Line W,U low voltage	Check the AC voltage protection setting. Check the voltage difference between LCD and meter. Also need to check whether AC cables are all firmly and correctly connected.
F43	AC Line V,W over voltage	Check the AC voltage protection setting.And Check if the AC cable is too thin.Check the voltage difference between LCD and meter.
F44	AC Line V,W low voltage	Check the AC voltage protection setting. Check the voltage difference between LCD and meter. Also need to check whether AC cables are all firmly and correctly connected.
F45	AC Line U,V over voltage	Check the AC voltage protection setting.And Check if the AC cable is too thin.Check the voltage difference between LCD and meter.
F46	AC Line U,V low voltage	Check the AC voltage protection setting.
F47	AC Over frequency	Check the frequency protection setting.
F48	AC lower frequency	Check the frequency protection setting.
F49	U phase grid current DC component over current	Hardly appear the code. Never ever happened so far.
F50	V phase grid current DC component over current	Hardly appear the code. Never ever happened so far.
F51	W phase grid current DC component over current	Hardly appear the code. Never ever happened so far.
F52	AC inductor A, phase current DC current high	Hardly appear the code. Never ever happened so far.
F53	AC inductor B, phase current DC current high	Hardly appear the code. Never ever happened so far.
F54	AC inductor C, phase current DC current high	Hardly appear the code. Never ever happened so far.
F55	DC busbar voltage is too high	1. Check PV voltage and Ubus voltage and its detection circuit. If the PV input voltage exceeds the limit, please reduce the number of solar panels in series. 2. For Ubus voltage, please check the LCD display.

<i>Error code</i>	<i>Description</i>	<i>Ongrid - Three Phase</i>
F56	DC busbar voltage is too low	<ol style="list-style-type: none"> <li>1. It tells the PV input voltage is low and it always happens in the early morning.</li> <li>2. Check PV voltage and Ubus voltage. When inverter is running, then showing F56, maybe Loss of driver or need update firmware.</li> <li>3. Restart the inverter, if the fault still exists, contact your installer or Deye service.</li> </ol>
F57	AC reverse irrigation	AC reverse irrigation.
F58	AC grid U over current	Hardly appear the code. Never ever happened so far.
F59	AC grid V over current	Hardly appear the code. Never ever happened so far.
F60	AC grid W over current	Hardly appear the code. Never ever happened so far.
F61	Reactor A phase over current	Hardly appear the code. Never ever happened so far.
F62	Reactor B phase over current	Hardly appear the code. Never ever happened so far.
F63	ARC fault	<ol style="list-style-type: none"> <li>1. Check PV module cable connection and clear the fault;</li> <li>2. Seek help from us, if can not go back to normal state.</li> </ol>
F64	IGBT heat sink high temperature	<ol style="list-style-type: none"> <li>1. Check temperature sensor. Check if firmware is suitable for the hardware. Check if the inverter is its right model.</li> <li>2. Restart the inverter, if the fault still exists, contact your installer or Deye service.</li> </ol>

Table10.1 Error codes and their solutions



**Note:**

If your string inverter has any of the fault information shown in Table 10-1, and when you reset the machine and still don't solve the problem, please contact our distributor and provide the below details:

1. Serial number of the inverter;
2. The distributor/dealer of the inverter(if available);
3. Installation date;
4. The discription of problem(include LCD'error code and LED status indicator lights);
5. Your contact details.

## 11.Specification

<b>Model</b>	<b>SUN-18K-G05-AU</b>	<b>SUN-20K-G05-AU</b>	<b>SUN-25K-G05-AU</b>
<b>Input Side</b>			
Max.DC Power(kW)	23.4	26	32.5
Max.DC Input Voltage(V)		1000	
Start-up DC Input Voltage(V)		250	
MPPT Operating Range(V)		200~850	
Max.DC Input Current(A)		39+39	
Max.DC Input Current(A)		26+26	
Number of MPPT/Strings per MPPT		2/2+2	
<b>Output Side</b>			
Rated Output Power(kW)	18	20	25
Max.Active Power(kW)	18	20	25
Rated AC Grid Voltage(V)		400V/340V-440V	
AC Grid Voltage Range(V)		277 ~ 460 (this may vary with grid standards)	
Rated Grid Frequency(Hz)		50Hz/45Hz-55Hz	
Operating Phase		Three phase	
Rated AC Grid Output Current(A)	26.1	29	36.2
Max.AC Output Current(A)	26.1	29	36.2
Output Power Factor		0.8 leading~0.8 lagging	
Grid Current THD		<3%	
DC Injection Current(mA)		<0.5%	
Grid Frequency Range		47-52 or 57-62 ( optional)	
<b>Efficiency</b>			
Max.Efficiency		98.5%	
Euro Efficiency		97.8%	
MPPT Efficiency		>99%	
<b>General Data</b>			
Size(mm, W×H×D)		362×527×220	
Weight(kg)		20	
Topology		Transformerless	
Internal consumption		<1W(Night)	
Operating temperature		-25 ~ 65 C ,>45 C derating	
Ingress protection		IP65	
Noise Emission(Typical)		≤ 40dB(A)	
Cooling Concept		Smart cooling	
Max. operation altitude		2000m	
Warranty		5 years	
Grid Connection Standard		AS/NZS 4777.2	
Operation surrounding humidity		0~100%	
Safety EMC / Standard		IEC/EN 62109-1,IEC/EN 62109-2,IEC/EN 61000-6-1,IEC/EN 61000-6-2,IEC/EN 61000-6-3,IEC/EN 61000-6-4	
<b>General Data</b>			
DC Connection		MC-4 mateable	
AC Connection		IP65 rated plug	
Display		LCD 240×160	
Interface		RS485/RS232/Wifi/LAN	

## NINGBO DEYE INVERTER TECHNOLOGY CO., LTD.

Add: No.26-30, South Yongjiang Road, Beilun, 315806, Ningbo, China

Tel: +86 (0) 574 8622 8957

Fax: +86 (0) 574 8622 8852

E-mail: [service@deye.com.cn](mailto:service@deye.com.cn)

Web: [www.deyeinverter.com](http://www.deyeinverter.com)

Ver: 2.2, 2022-03-10